

419-898-3305



C. NELSONMFG .. www.cnelson.com
265 N. LAKE WINDS PKWY.,
OAK HARBOR, OH 43449
419-898-43305 X 201 sales@cnelson.com

Mobile Dipping Carts, Your Best Deal and Lowest Prices Online

Nelson Mobile scooping carts are designed for use ANYTIME or ANYWHERE

The mobile carts shown on these pages are the most common configurations we produce. Custom features and sizes are available. If you don't see what you want, just ask.

Complete drawings of all carts can be seen on our website, www.cnelson.com. Should you need a more detailed drawing, let us know. There, you will also find links to NSF and ETL showing our listings, if needed for your local health department.

We at Nelson do not simply buy an inexpensive store freezer and turn it into an outdoor cart. We build our carts from the ground up in Oak Harbor, Ohio, and build them to last and perform in the heat of the outdoor summers.

Our sink systems are approved by NSF, LA County and Clark County, Nevada. Should you need specific information for those locales, Call or e-mail.

Our ice cream, Italian Ice or Gelato carts can be made with stainless flip lids (recommended for outdoor use) or with an open-top as a visual dipping cabinet. While we recommend the stainless flip lids for outdoor use, the visual display model can come with optional sliding lids that will help the ice cream freezer hold temperature outdoors, and is easily added or taken off to suit the conditions. For instance, the same cart can be used as a visual display ice cream dipping cart in a sports arena or convention center or the sliding lid set can be added for use outdoors if conditions require.

With the exclusive Nelson digital temperature control, standard on all dipping carts, you can easily use the same cart for a wide variety of products, from the warmer temperatures of soft frozen water ices or Italian ice, to gelato, or ice cream products requiring temperatures of -20 degrees or colder. The digital temperature control allows for the precise setting of the temperature 1 degree at a time.



BD8CE-06



BD6CE -05



BD8DIPCE-01



BD4DIPCE-00+



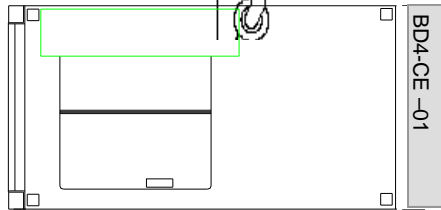
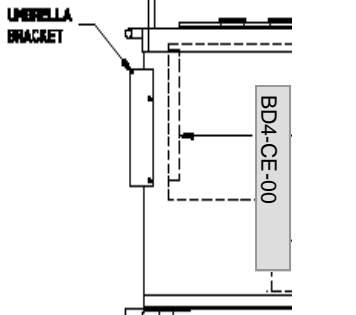

56
OUTSIDE S.S. TOP

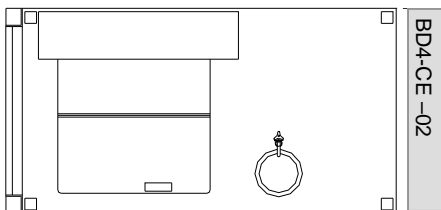

56
OUTSIDE S.S. TOP

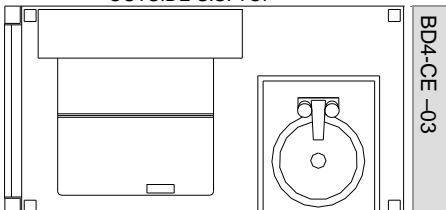

56
OUTSIDE S.S. TOP

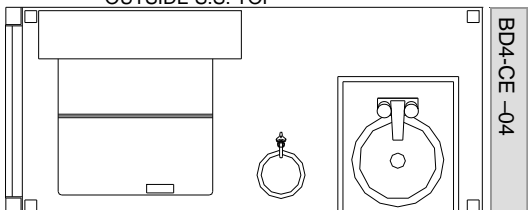

68
OUTSIDE S.S. TOP

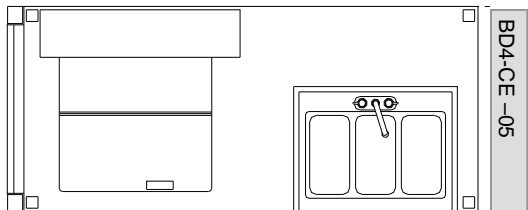

68
OUTSIDE S.S. TOP

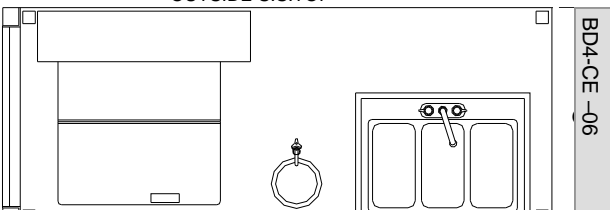

74 3/4
OUTSIDE S.S. TOP



www.cnelson.com, sales@cnelson.com
265 N. Lake Winds Parkway
Oak Harbor, OH 43449, U.S.A.
Anytime, Anywhere

BD4DIPCE-02

Canopy Light Fixture with Storage Shelf for Lightweight Paper Products

Canopy when Recessed

Pull Out Shade for Operator

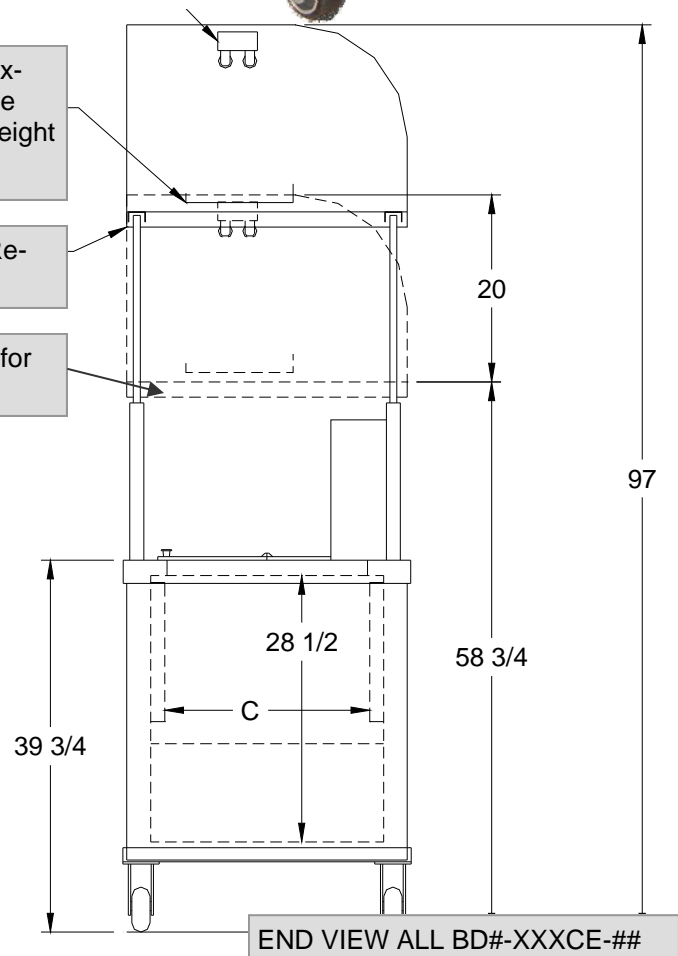



www.cnelson.com, sales@cnelson.com
 265 N. Lake Winds Parkway
 Oak Harbor, OH 43449, U.S.A.
 Anytime, Anywhere

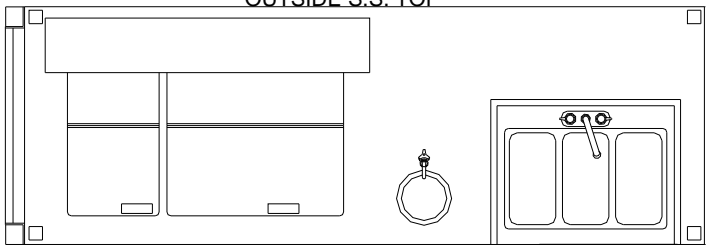
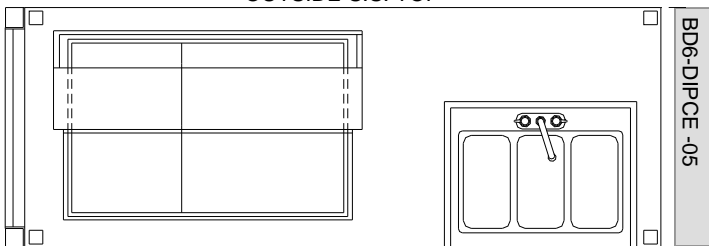
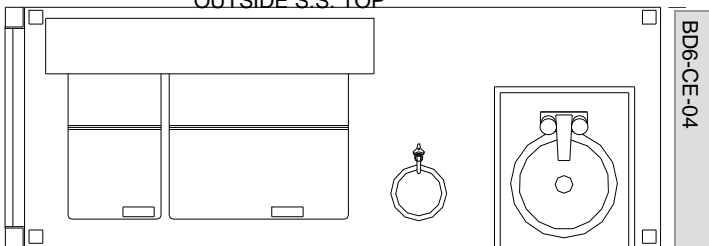
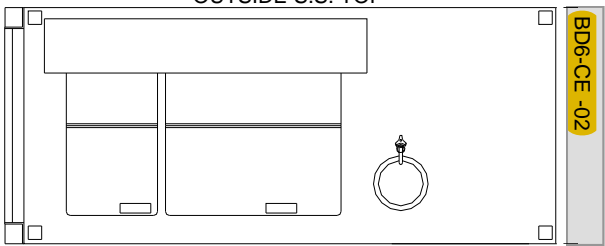
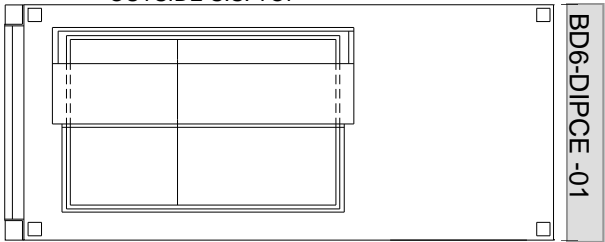
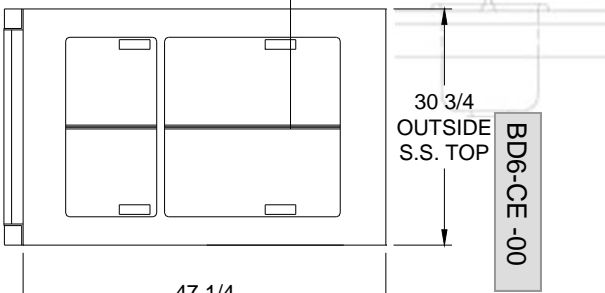

Options available on all carts- fold-down shelves, cold plates, overhead canopies, cup dispensers, or whatever else you may need to run your ice cream business.

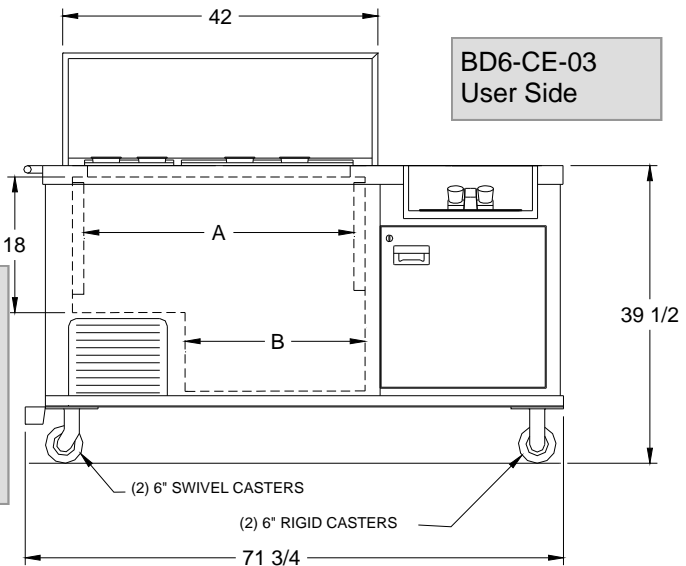
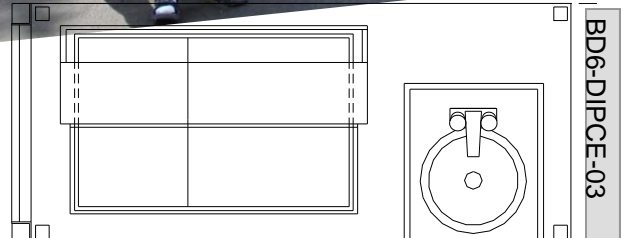

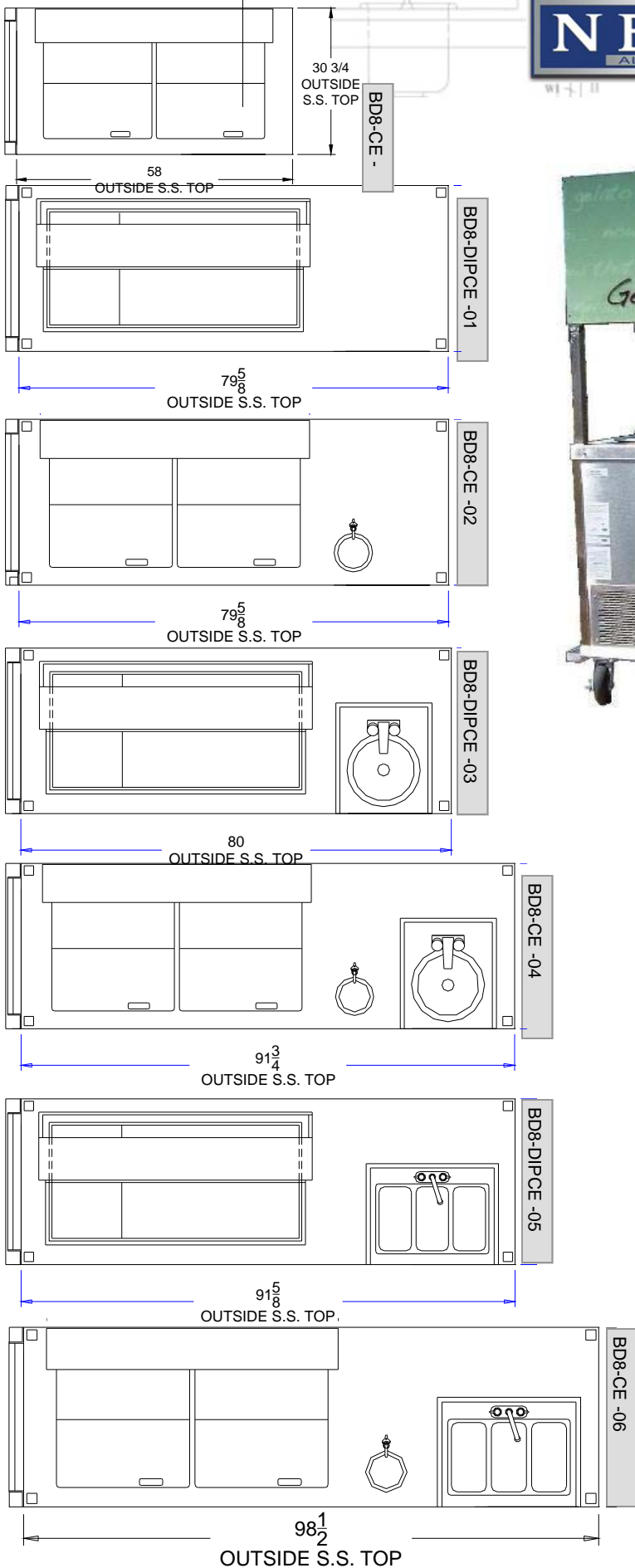

**Specifications for Models
BD#-(DIP)CE-##:**

- Lid Locks standard on all cart models
- Top to be stainless steel, standard. Optional solid surface or laminate materials available.
- Base frame welded aluminum
- All exposed corners welded and polished smooth
- Finished exterior white lexan standard. Other graphic options available
- Wheels 6" diameter hard rubber (2) swivel w/ brake (2) rigid. Load rating of wheel a minimum of 350lbs ea. Optional 8" casters available.
- Interior stainless steel, standard
- Bottom drain for defrost.
- Electronic thermostat standard.
- 5 year limited warranty against cold plate defect, insulation failure or internal tubing leaks.
- NSF & ETL approved for outdoor use.
- 115volts, optional 220 volts
- Sink system requires separate 15 amps of 115 volt electricity.